

**FALLPROTEC**

Height Safety Products

+352 26 55 09 30 | [www.fallprotec.com](http://www.fallprotec.com)

# FALLPROTEC

## RIGID RAIL FOR HEIGHT SAFETY





Tarragona, Spain

# RIGID RAIL FOR HEIGHT SAFETY

EN795:2012 Type D

ANSI/ASSP Z359.6

The SafeAccess is an undeformable fall arrest rail for industrial applications. Installed in overhead configuration, it is the most suitable system when the fall clearance is low. ATEX certified for potentially explosive atmospheres, this rail is also ideal for petrochemical industries and highly corrosive environments. The aluminium rail is protected by a high-quality powder coated surface treatment that resists to marine environment.

# An ultra-resisting height safety rail

The SafeAccess is tested and certified according to European and ANSI standards.

- Undeformable in case of a fall
- ATEX certified for explosive atmospheres
- Up to 4 users simultaneously
- Low maintenance
- Follows the end user instantly
- Bendable on demand (min. radius = 600mm)
- Fixed to steel structure or concrete

Applications:



Industrial

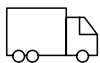

Loading bays

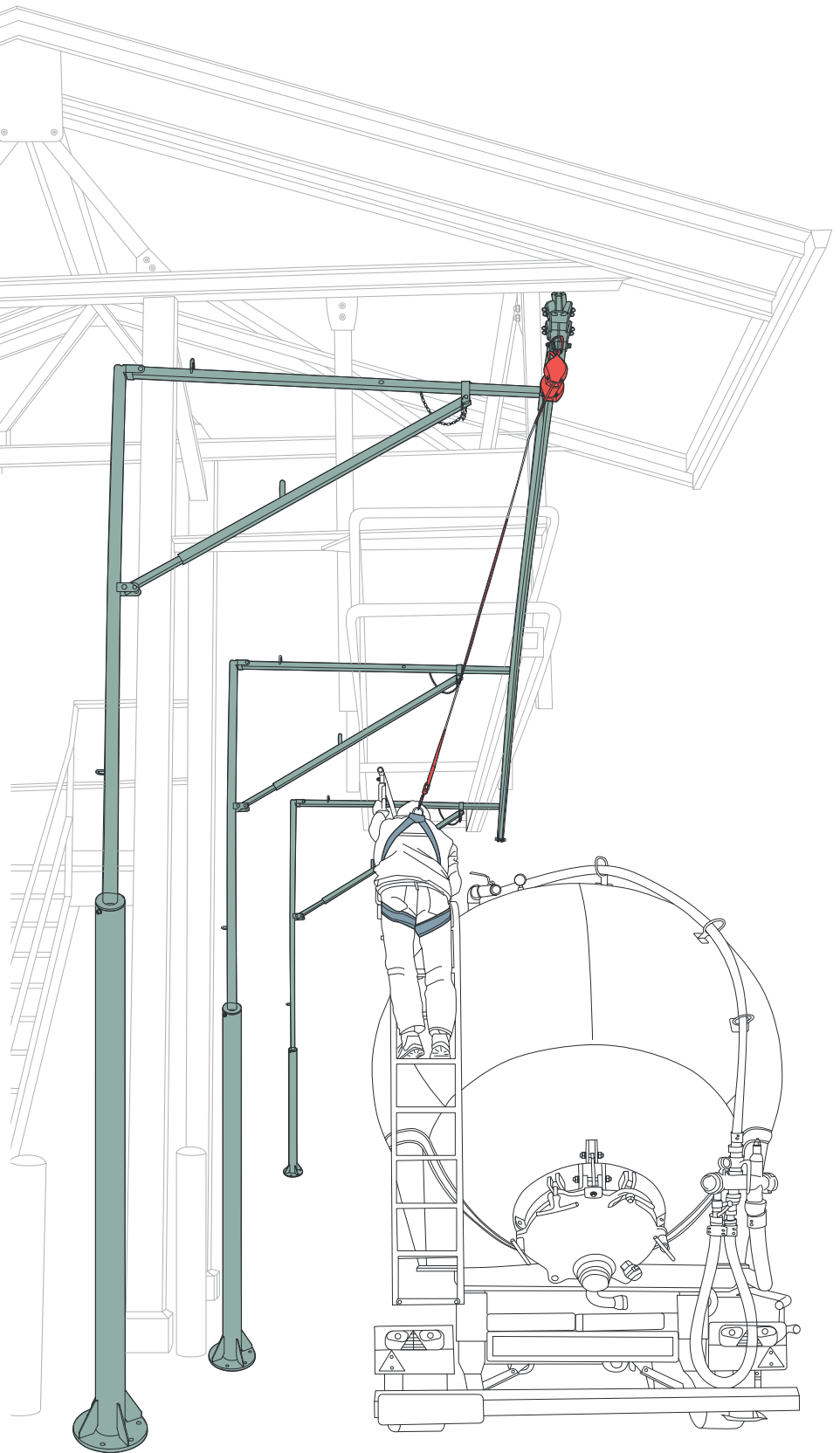

# SafeAccess rail for fallarrest

The SafeAccess can be used for fall arrest in many combinations: ground, wall, ceiling or jibs above a loading bay. The robust design suits intensive applications, the rail remains usable years after being installed. In case of a fall, it is one of the very few systems where there will be no need to replace any part. Combined with a safety block enables the safest possible fall arrest.

EN795:2012 Type D | CEN/TS16415:2013



X 4  
(2 users with  
Flexbow)



Click here to follow the product YouTube playlist

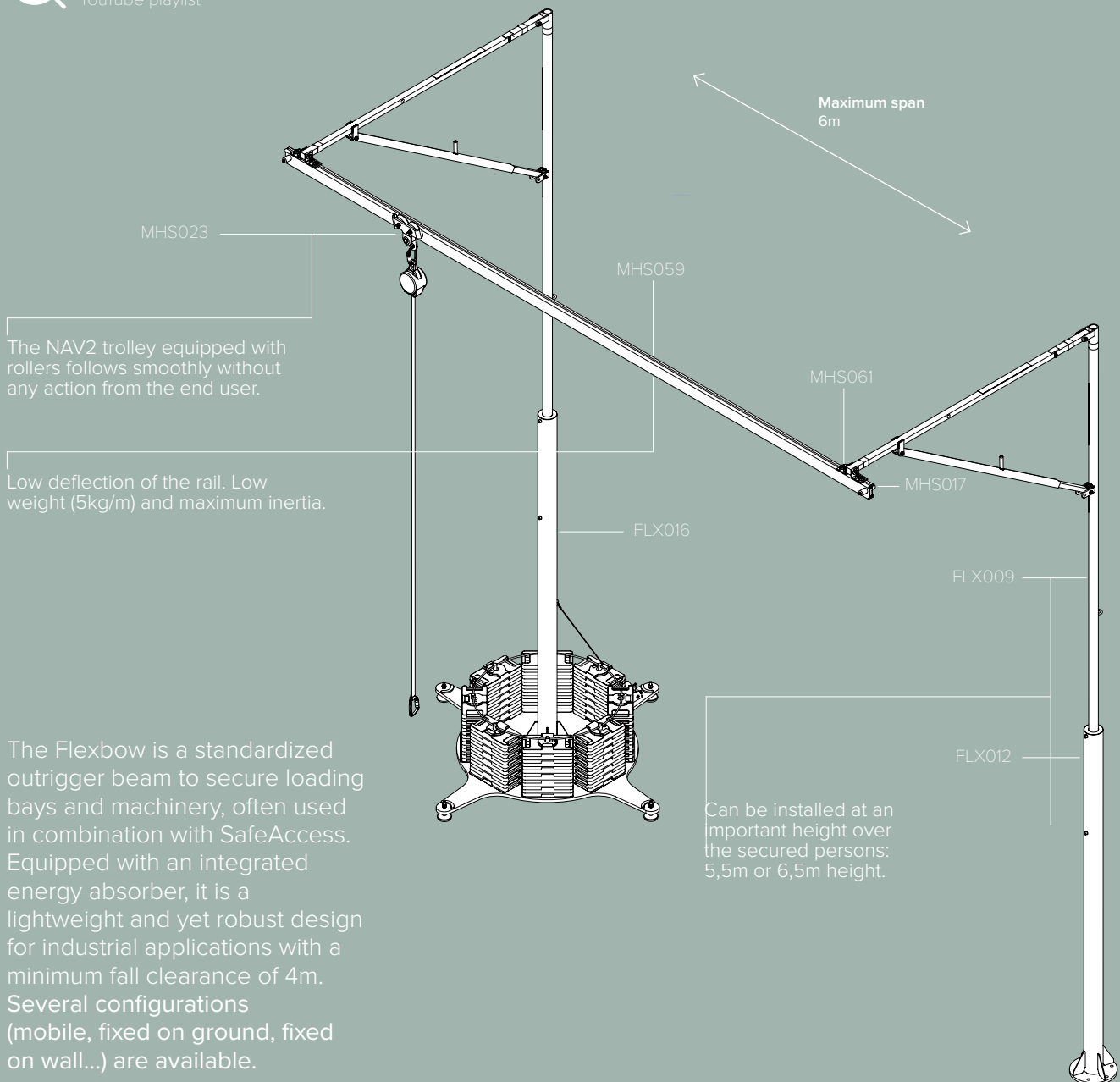

The Flexbow is a standardized outrigger beam to secure loading bays and machinery, often used in combination with SafeAccess. Equipped with an integrated energy absorber, it is a lightweight and yet robust design for industrial applications with a minimum fall clearance of 4m. Several configurations (mobile, fixed on ground, fixed on wall...) are available.

# Fixing brackets

Fixing the rigid rail on existing industrial sites is facilitated thanks to the standardized fixing brackets of Fallprotec. The rail is generally mounted to the ceiling with either:

- Plate MHS038 for concrete
- Universal fixing plates for clamping on beams between 50 and 300mm width.
- Adjustable hanger brackets.
- Rigid welded steel hanger brackets

## Ceiling bracket

It comes with MHS062 bolts

MHS038



## Fixing bracket by clamping

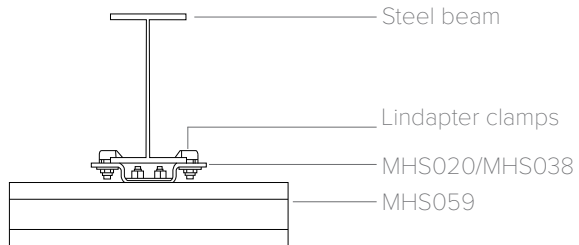

The adjustable brackets enable to:

- Adapt to the size of the beam (50 – 300mm)
- Compensate the slope of the roof
- Tube length can be cut on site to adapt to final measurements.
- Quick delivery with standard components



# Trolleys

## NAV2 for fall arrest

Trolley in stainless steel with POM wheels. Follows instantly the end user when he walks, even if the rail is installed 20 meters above the walking surface. Typically combined with a self-retractable lanyard.

MHS023



# Fallprotec's SafeAccess lifelines worldwide

Click here to view more  
case studies worldwide  
on our website



## CHOOSING FALLPROTEC MEANS

- One reference for global assistance
- Certified by notifying bodies as per latest European standard
- Quality control: ISO9001:2015.  
E.C. Quality of Production « Article 11B »
- Product liability insurance
- Warranty
- One-Stop-Shop



📍 Truck loading station  
France

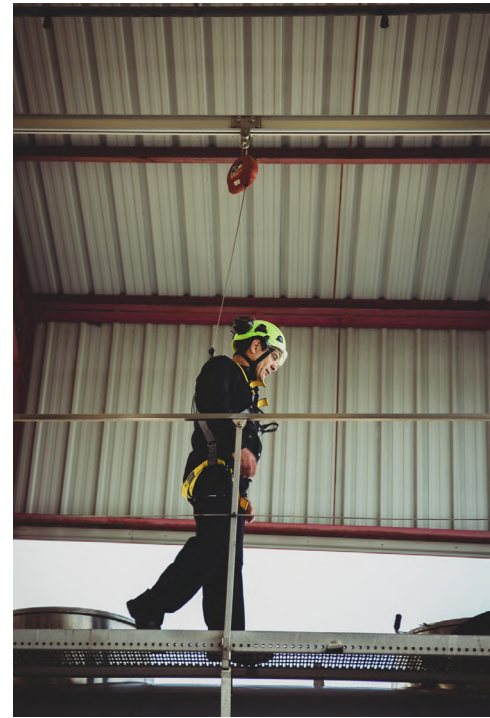
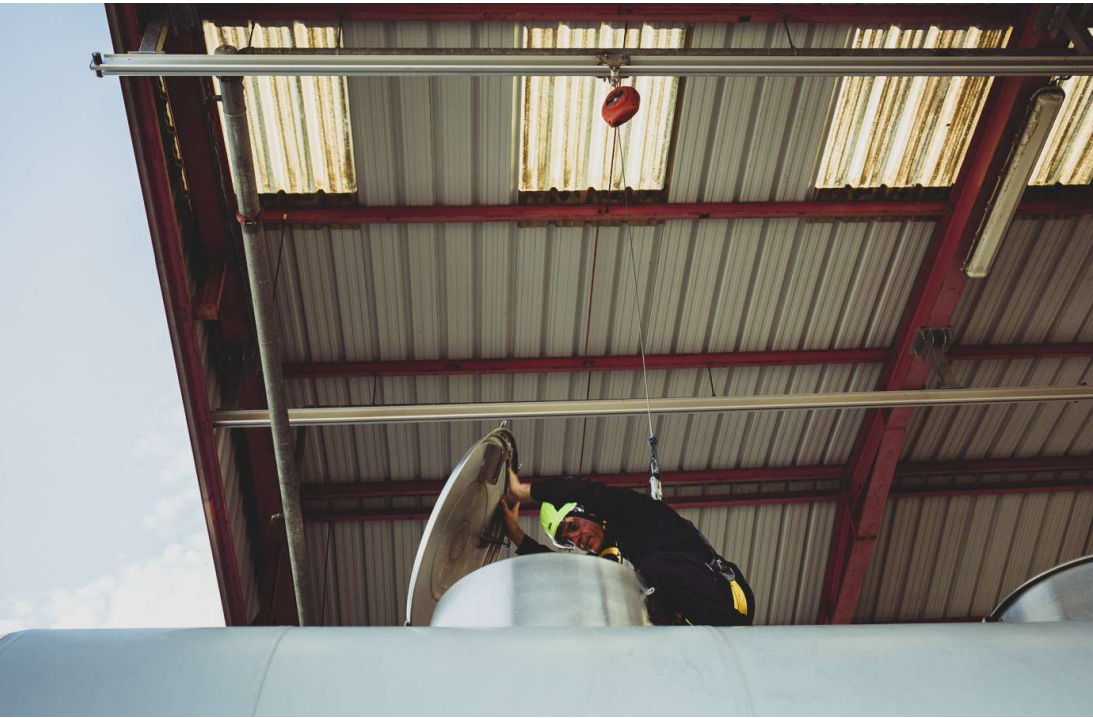

📍 Oil&Gas loading station  
Tarragona, Spain



📍 SNCB  
Mechelen, Belgium

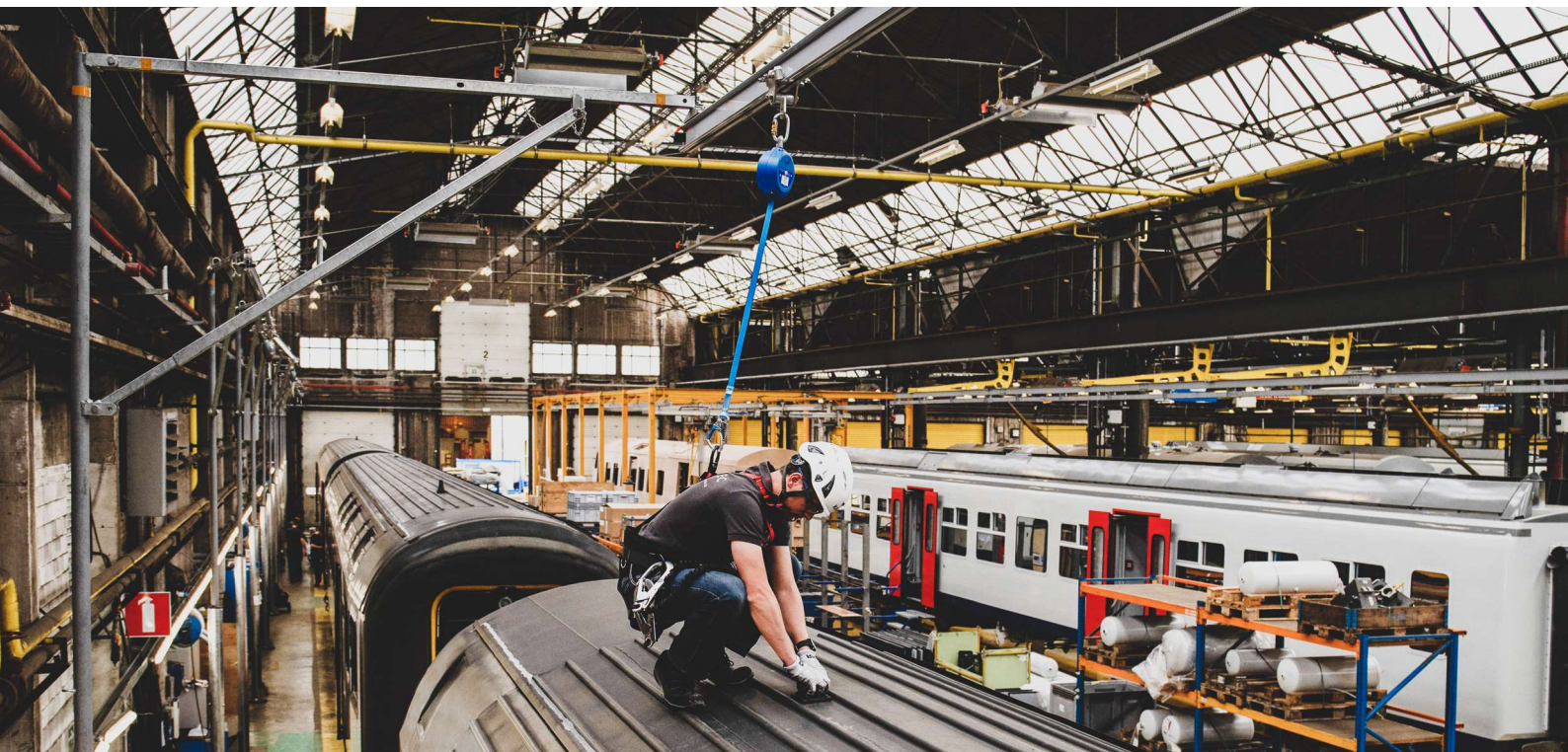

📍 Airbus  
Toulous, France





📍 Query  
Arganda del Rey, Spain

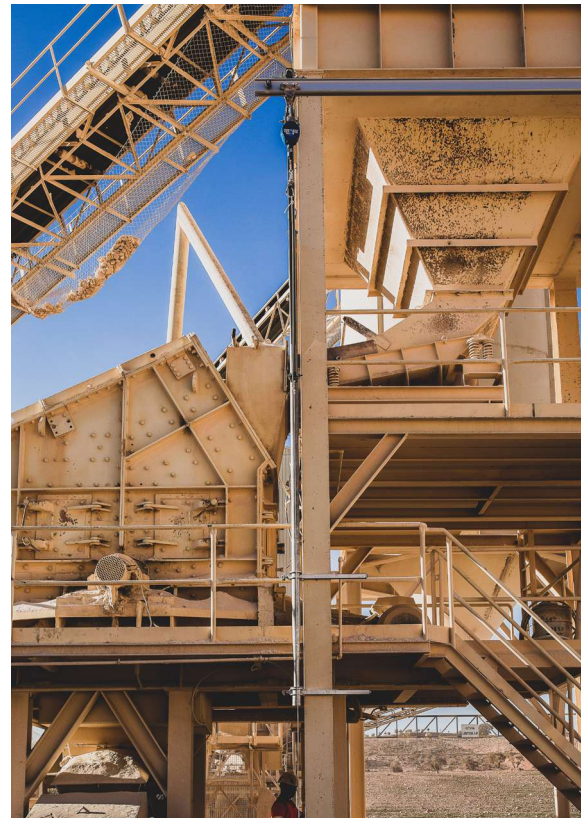
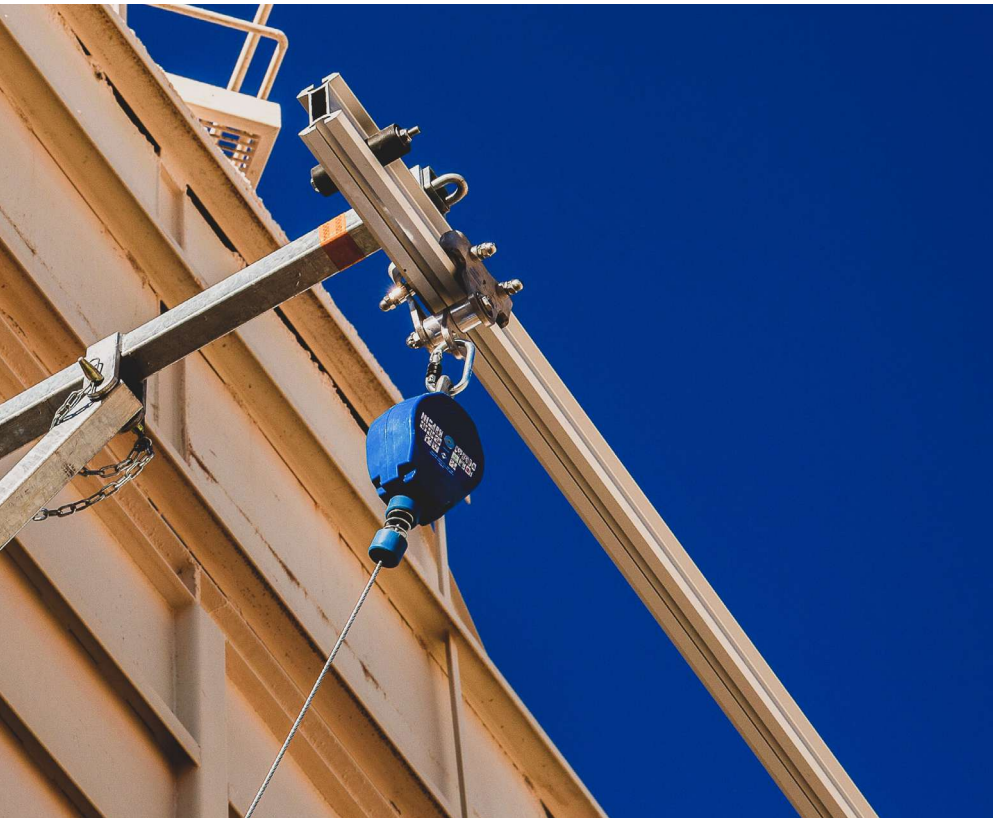

📍 Formwork industry  
Montcada i Reixac, Spain

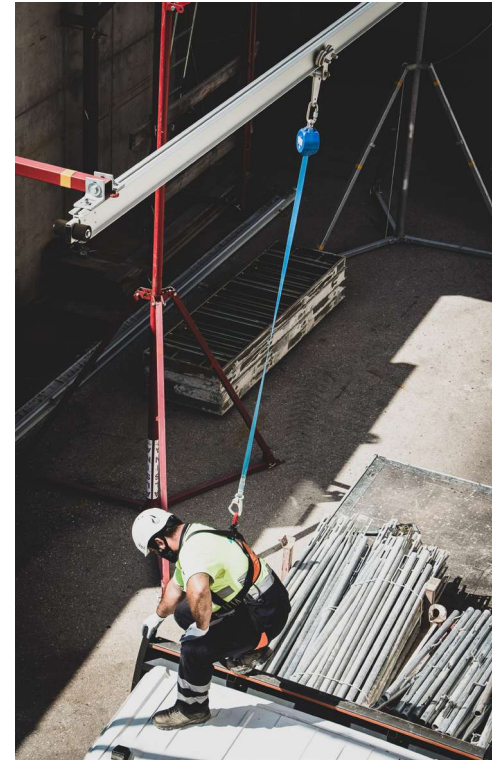

📍 BlueSun  
Mataró, Spain



### FALLPROTEC SA

43-45 ZA Op Zaemer  
4959 Bascharage  
Luxembourg  
T: +352 26 55 09 30  
F: +352 26 55 09 30 55  
marketing@fallprotec.com

### FALLPROTEC SL

Eduard Calvet i Pintó 4  
Pol. Ind. Vallmorena  
08339 Vilassar de Dalt  
Spain  
T: +34 93 114 22 31  
info@fallprotec.es

### FALLPROTEC CHINA

Room 213, Building 6  
No. 398, Jinglian Road  
Minhang District  
Shanghai, China

T: +86 21 3126 8606  
F: +86 21 2281 0168

+352 26 55 09 30  
[www.fallprotec.com](http://www.fallprotec.com)

Follow us

fallprotec |    

**FALLPROTEC**

Height Safety Products

