

FALLPROTEC

Height Safety Products

+352 26 55 09 30 | www.fallprotec.com



FALLPROTEC
FOR CEMENT FACTORIES



Arganda del Rey, Spain

RISKS ON CEMENT FACTORIES

Fall from height is the second-biggest cause of fatalities in the cement industry (21%), after traffic & mobility plant.

It is linked to the design of cement factories, the amount of machines used and the type of work required.

Another serious hazard is the work completed in confined spaces, as silos need to be cleaned on a regular basis.

Source:
Çankaya, Selçuk & Taner Çankaya, Simge. (2015). OCCUPATIONAL HEALTH AND SAFETY IN CEMENT INDUSTRY.

If there is no collective protection to eliminate the risk of falling, workers must be provided with and trained in the use of appropriate fall protection equipment, such as lifelines and EPs. Likewise, an appropriate and timely rescue should be provided to prevent suspension trauma.

- **SecuRope Horizontal (p. 5)**
- **SecuRope Horizontal Overhead (p. 7)**
- **SecuRail Pro Horizontal (p. 9)**
- **SecuRope Vertical (p. 11)**
- **SafeAccess fall arrest (p. 13)**
- **Davit arm and Tripod (p. 15)**
- **Self retractable lanyard (p. 17)**

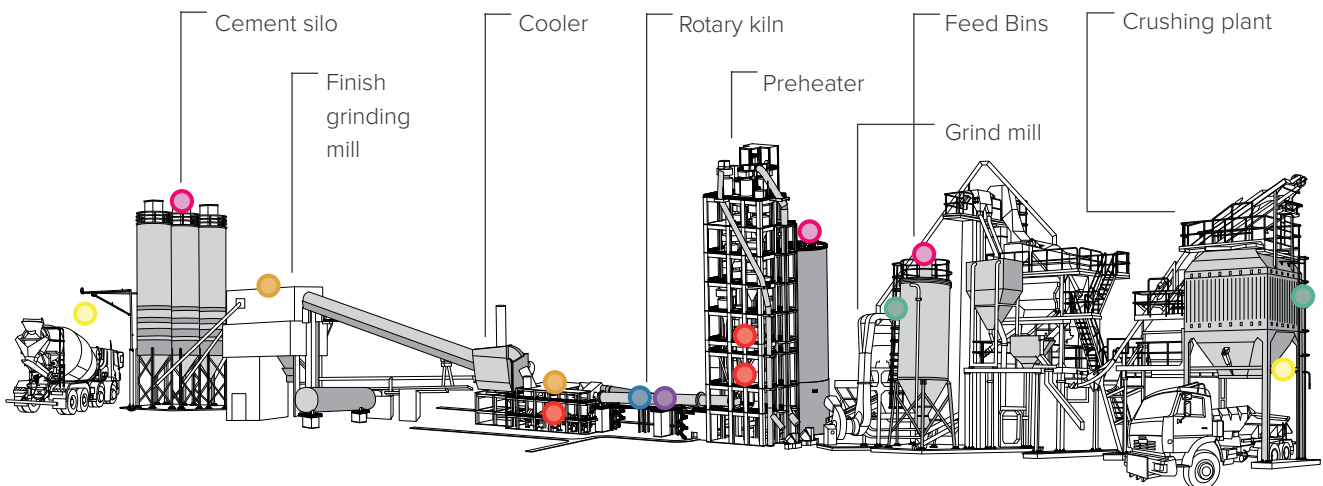

CHOOSING FALLPROTEC MEANS

- One reference for global assistance
- Certified by independent notifying bodies as per latest European
- Quality control: ISO9001:2015. E.C. Quality of Production « Article 11B »
- Product liability insurance
- Warranty
- One-Stop-Shop



Maintenance of roofs

The smog particles produced by cement production often fall back onto the roof, creating a heavy load and fragilizing its structure. Work at height in that roofs is a high-risk activity not only for the risk of falling from the edge but also falling through. Fallprotec can provide not only lifelines but also gangways.

— Maintenance of roofs induce a high risk of hitting an obstacle if falling through and pendulum effect if falling from the edge. Fallprotec recommends installations with low-deflection elements such as rail or retractable fallarresters.



SecuRope lifeline on cold deck roof for corrugated metal sheet roofs. Combined with the energy absorbing mechanism of the SecuRope NEO cable lifeline, it is the best system for fragile roofs. Ideal for the maintenance and repair of any industrial facility.

EN795:2012 Type D | CEN/TS16415:2013



Click here to follow the product YouTube playlist

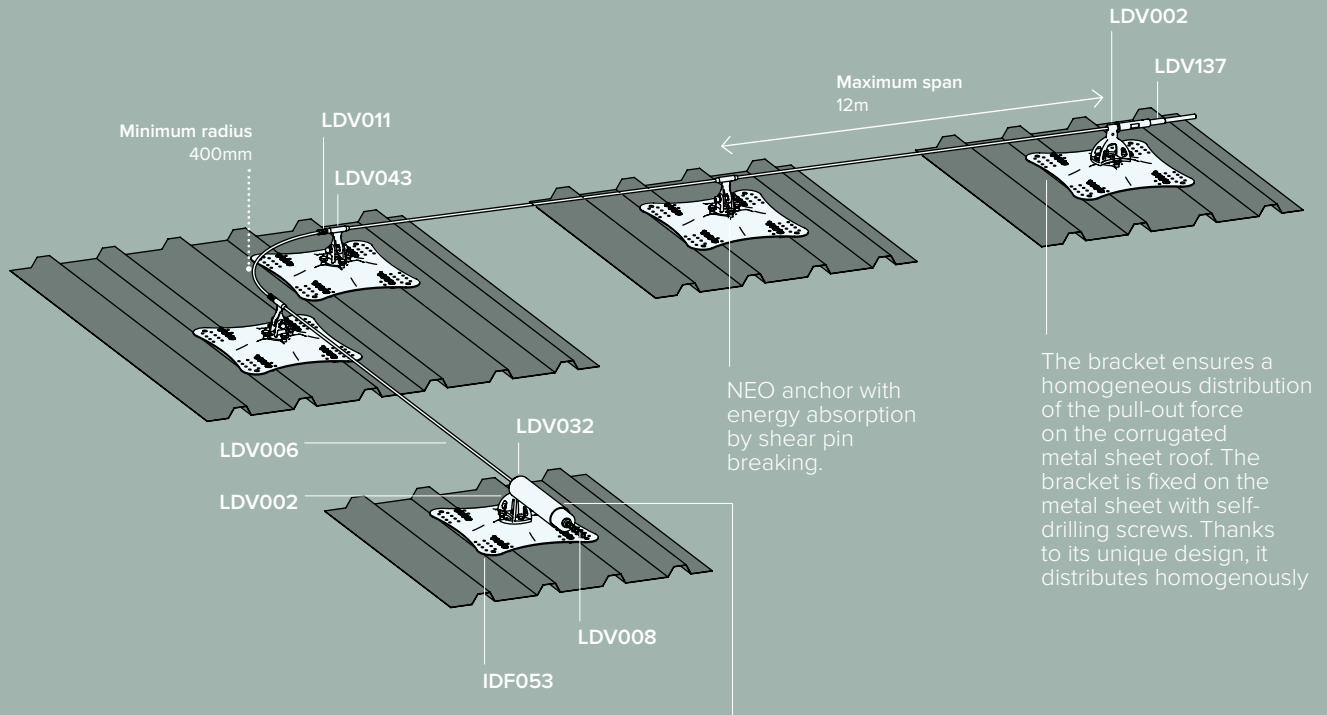

The energy absorber is a key component of an engineered cable lifeline. It reduces the forces transmitted to the host structure. Combined with the intermediate anchor LDV043 with integrated shock absorber, it enables the installation of the cable lifeline on a great variety of fragile roofs and structures. The energy absorber has 4 functions: energy absorption in case of a fall, indicator of the tension in the line, upkeep of the tension in the line and indicator of a fall.

Fixing assembly on metallic purlin LDV137



Gangway fixing assembly

Walking on corrugated metal sheet roofs can be risky, which is why roof gangways are recommended beside the fall arrest equipment.

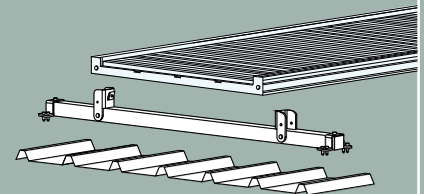

Maintenance of kilns

Cement extraction workers are exposed to a high risk of fall from height when maintaining the kiln. Indeed, kilns are rounded surfaces exposed to outside weather conditions, which can lead them to become fragile or slippery.

The Securope is a solution for this type of works, usable in overhead configuration. This cable lifeline can be single span, without intermediate anchors, but only under supervision of Fallprotec's engineering department.

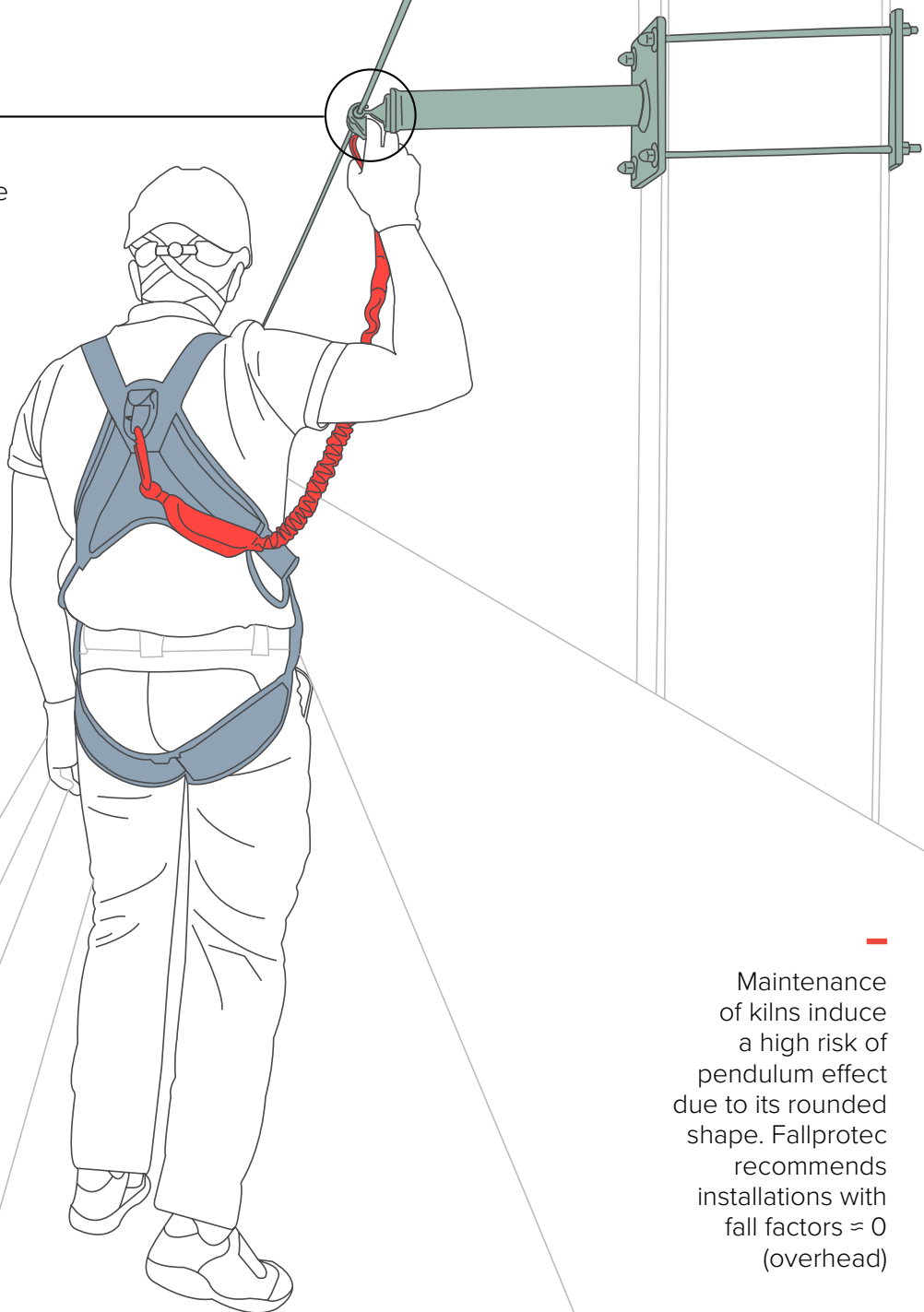

Maintenance of kilns induce a high risk of pendulum effect due to its rounded shape. Fallprotec recommends installations with fall factors ≈ 0 (overhead)

SecuRope lifeline between wall configuration with glider LDV133. For this type of configuration Fallprotec suggests the cable LDV005 construction 1x19 and \varnothing 8mm which reduces even more the deflection of the cable. Thanks to its properties it is also more resistant than others to high corrosive environments.



Click here to follow the product YouTube playlist

EN795:2012 Type C CEN/TS16415:2013



x 4
(2 users max. per span)

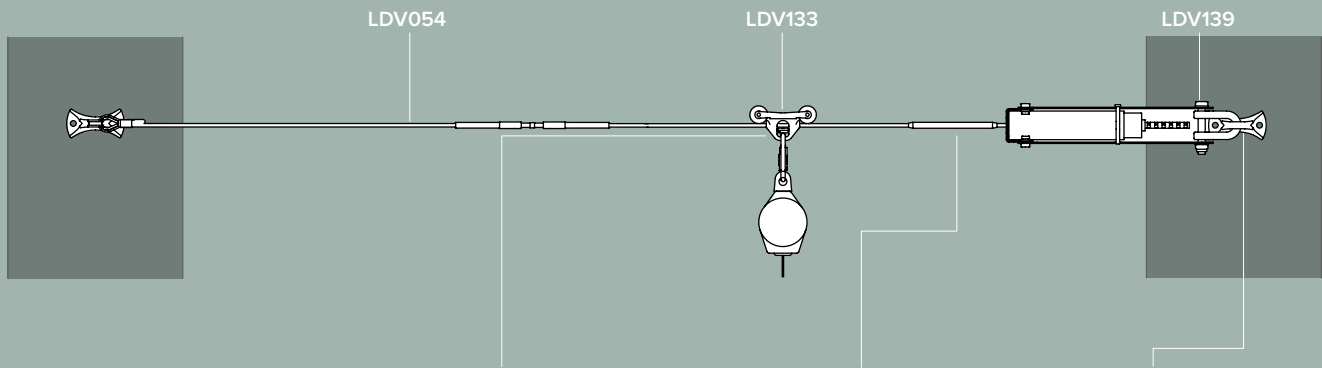

The LDV133 is the proper glider when the connecting device is a self-retractable fall arrester that weighs 10 kg or less. The glider passes smoothly over the intermediate anchors. The end user can move freely along the lifeline without disconnecting and hands-free to operate with tools. If the user is less than 3 m below the life line, a 2 m absorbing lanyard, connects the user to the captive glider LDV060.

Thanks to the cable crimping technology, the cable deflection is reduced in order to stop the fall in the shortest distance possible.

With its integrated energy absorbing mechanism, it reduces the load transmitted to the host structure.

*For longer spans than 12m please contact the Fallprotec's engineering department

Maintenance of roofs and machineries

Cement extraction workers may be exposed to a wide variety of rotating wellhead equipment, including crushers, grinding mills, ball and rod mills, separators mill headers/ends, trunion / mill headers, mill bearings, feeders, bucket belt, chain, conveyors... and might be injured if they are struck by or caught between unguarded machines.

The Securail Pro is a cost-efficient solution for this situation, as the same trolley can be used for applications on ground, wall or ceiling. With its low deflection, easy passage and high resistance to corrosion, it is a key companion for cement factories that include a lot of walkways between or above machines.

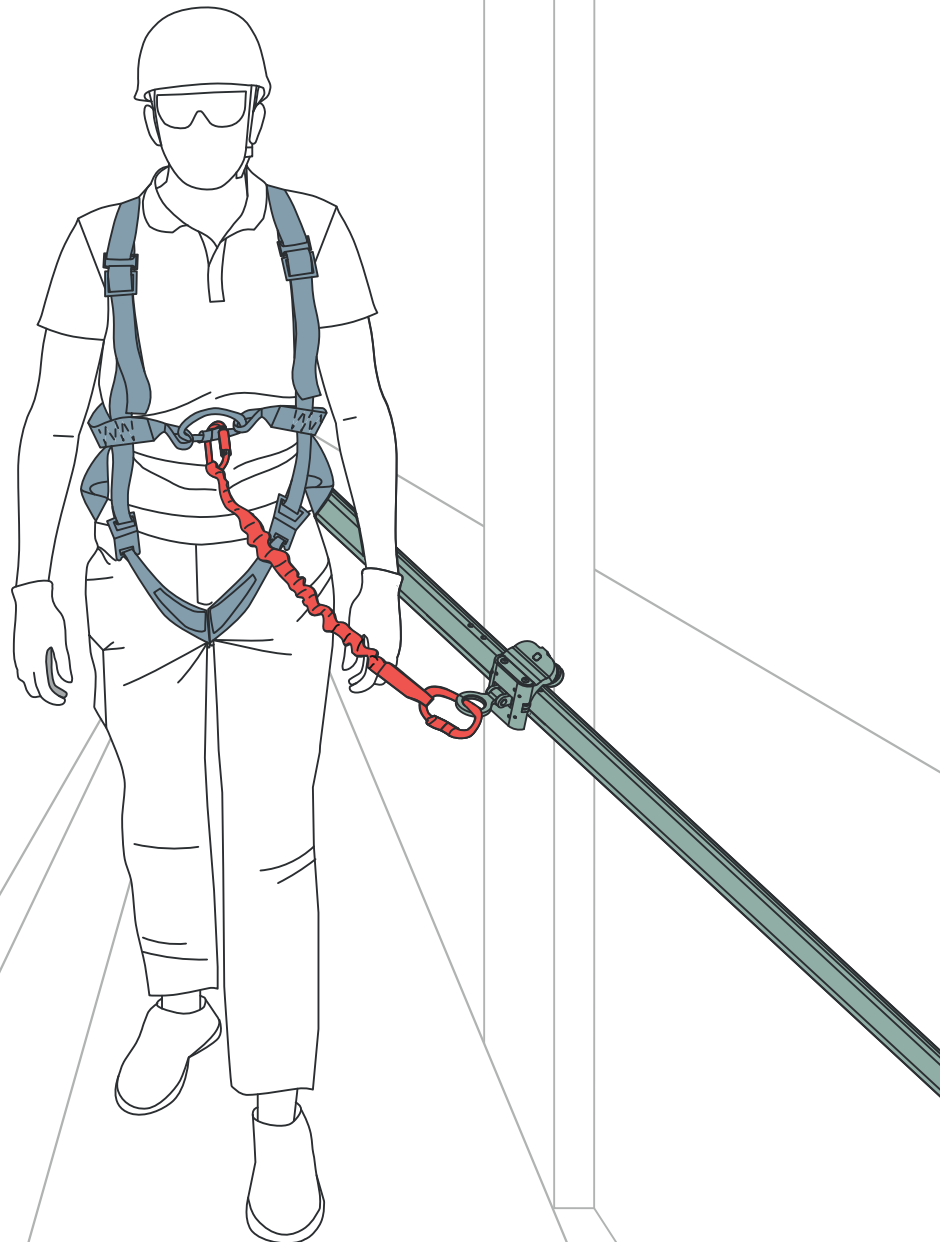

—
Cement applications have a low fall clearance due to the presence of machinery below the walkways. Fallprotec recommends installations with fall factors ≈ 0 (overhead)

SecuRail Pro lifeline on ground or wall, configuration with a GRANVIA trolley RHF511. The wall configuration is often used in the industry due to low fall clearance. Made of high resistance aluminium, the rail can be easily used in environments that are highly corrosive.

Click here to follow the product YouTube playlist

EN795:2012 Type D | CEN/TS16415:2013



x 2

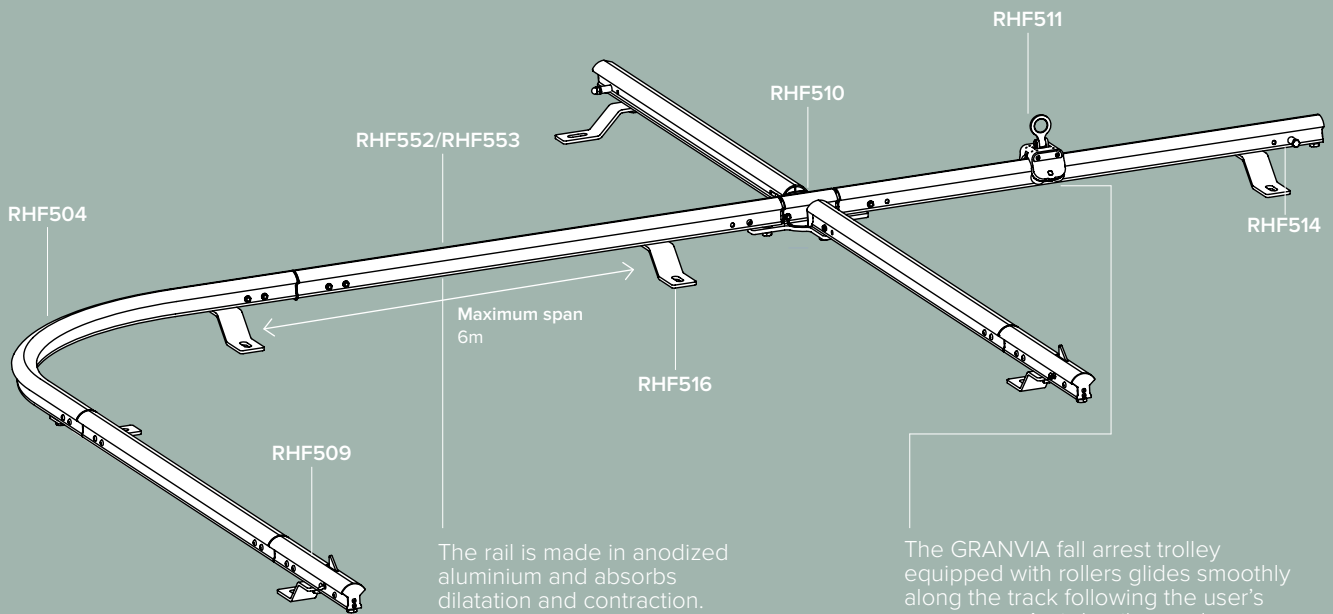

The rail is made in anodized aluminium and absorbs dilatation and contraction. Low deflection after activation.

The GRANVIA fall arrest trolley equipped with rollers glides smoothly along the track following the user's movement. Anti-derailment claws mounted between the rollers keep the trolley firmly on the track. The same trolley is used for ground, wall and ceiling configuration. The rollers enable a smooth gliding of the trolley.

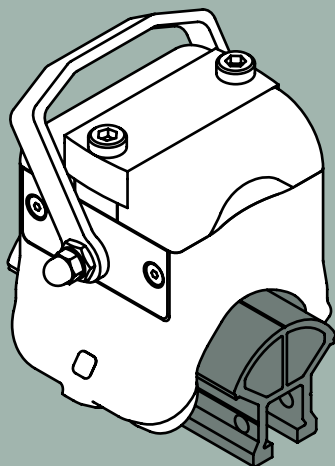

Overspeed Trolley

The new multidirectional trolley works either for inclined and horizontal lifelines. This allows the assembly of horizontal lifelines with sloped sections, all in one, avoiding the user's disconnection. Equipped with shock absorber, the installation is easy, directly on the rail.

Access to silos

Cement extraction facilities include confined elements such as silos. When maintaining them, workers have to access the inside and set up a net. There is therefore a high risk of falls from height while moving upwards or downwards. For this, the Securope vertical is an easy solution, allowing also the user to choose when to connect or disconnect on the lifeline.

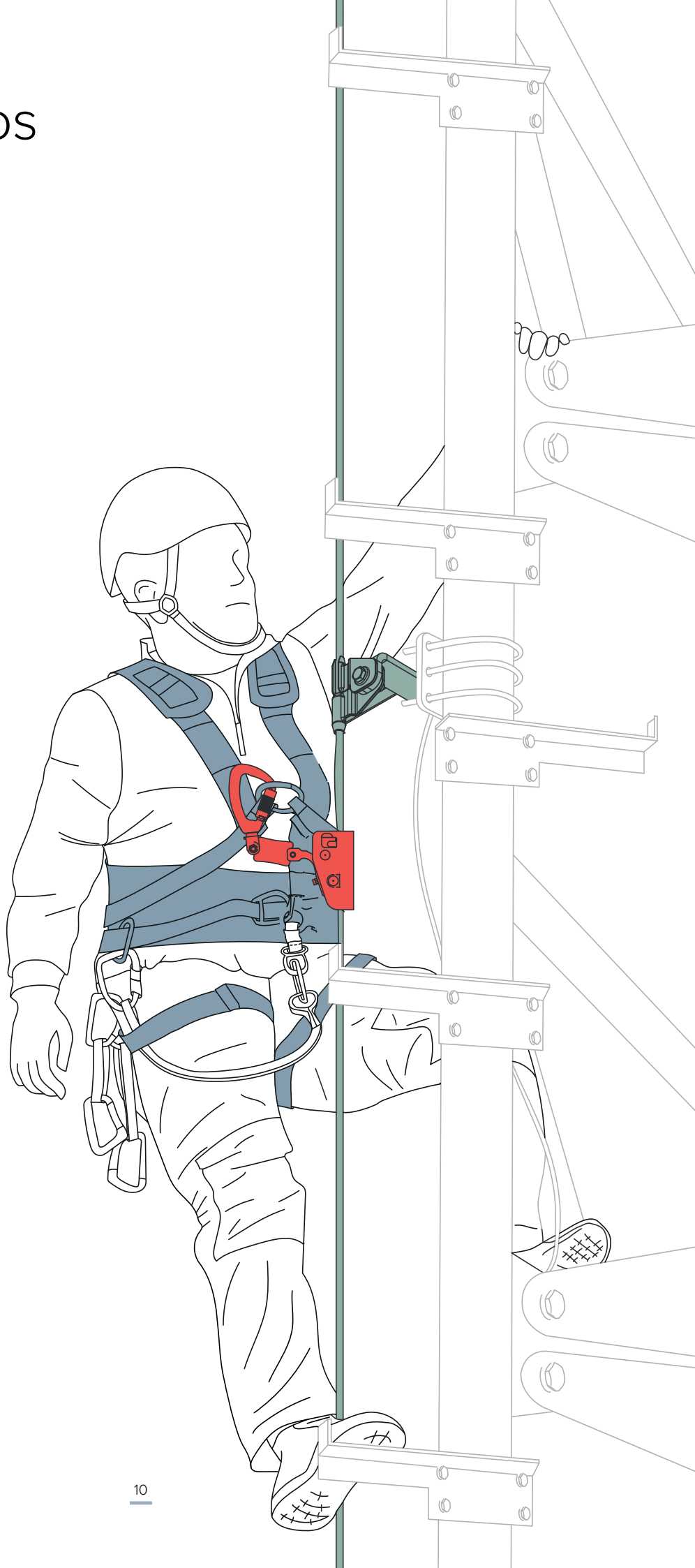

—
Cement production facilities have a high risk of fall as the silos' size is particularly huge. Fallprotec also recommends the use of temporary lifelines for the maintenance of the inner facade of silos.

Absorber on the lifeline



AISI 304

Absorber on the glider



AISI 304



Click here to follow the product YouTube playlist

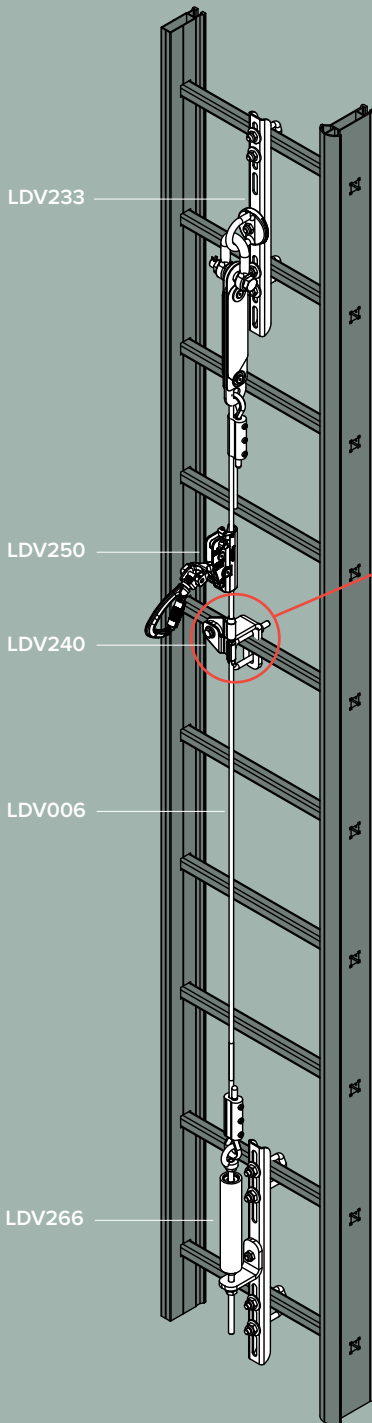

Intermediate anchors clipped on the cable, can easily be retrofitted on a lifeline. Span between anchors 10m (32'8")

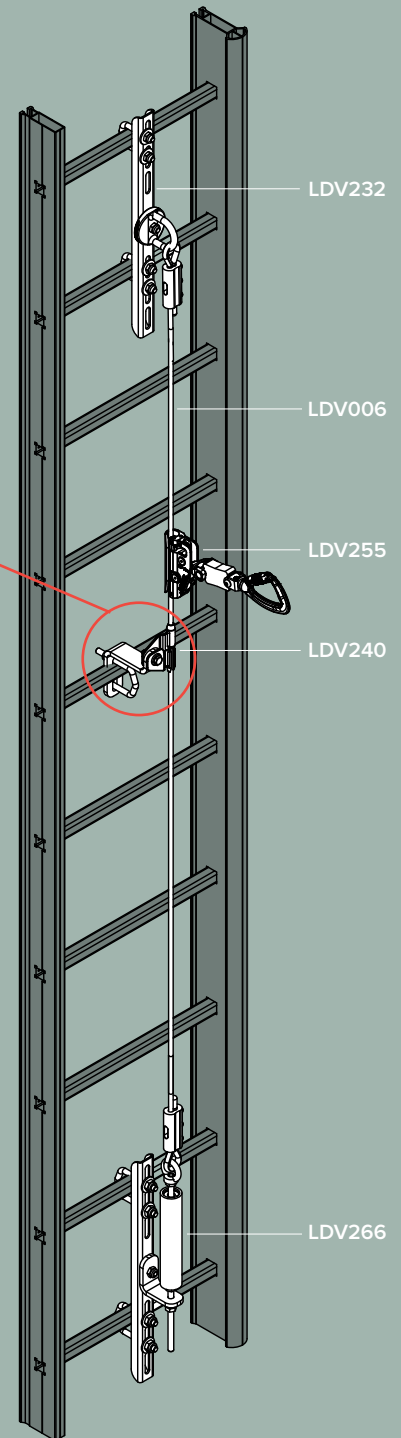
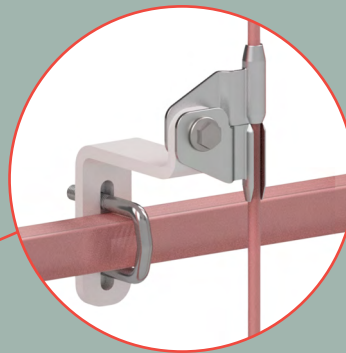

Fallprotec provides a vertical cable lifeline Securope. It can be retrofitted on an existing ladder or structure. Installed without crimping, it comes with an opening glider that allows the user to keep safely connected while being capable to connect to the lifeline at whichever time he wishes. The glider blocks automatically in case of a fall. Fallprotec suggests the use of the cable LDV005 construction 1x19 and \varnothing 8mm as it reduces even more the deflection of the cable. It is also more resistant than others to high temperature conditions and corrosive environments.

Loading ready-mix trucks and tightening the tarpaulin

Trucks can be loaded from the above. Workers have to place themselves at height in order to control the filling of the tank. Risks include the inhalation of toxic products and falls from height. In order to secure workers performing this task, Fallprotec provides safety ATEX equipments.

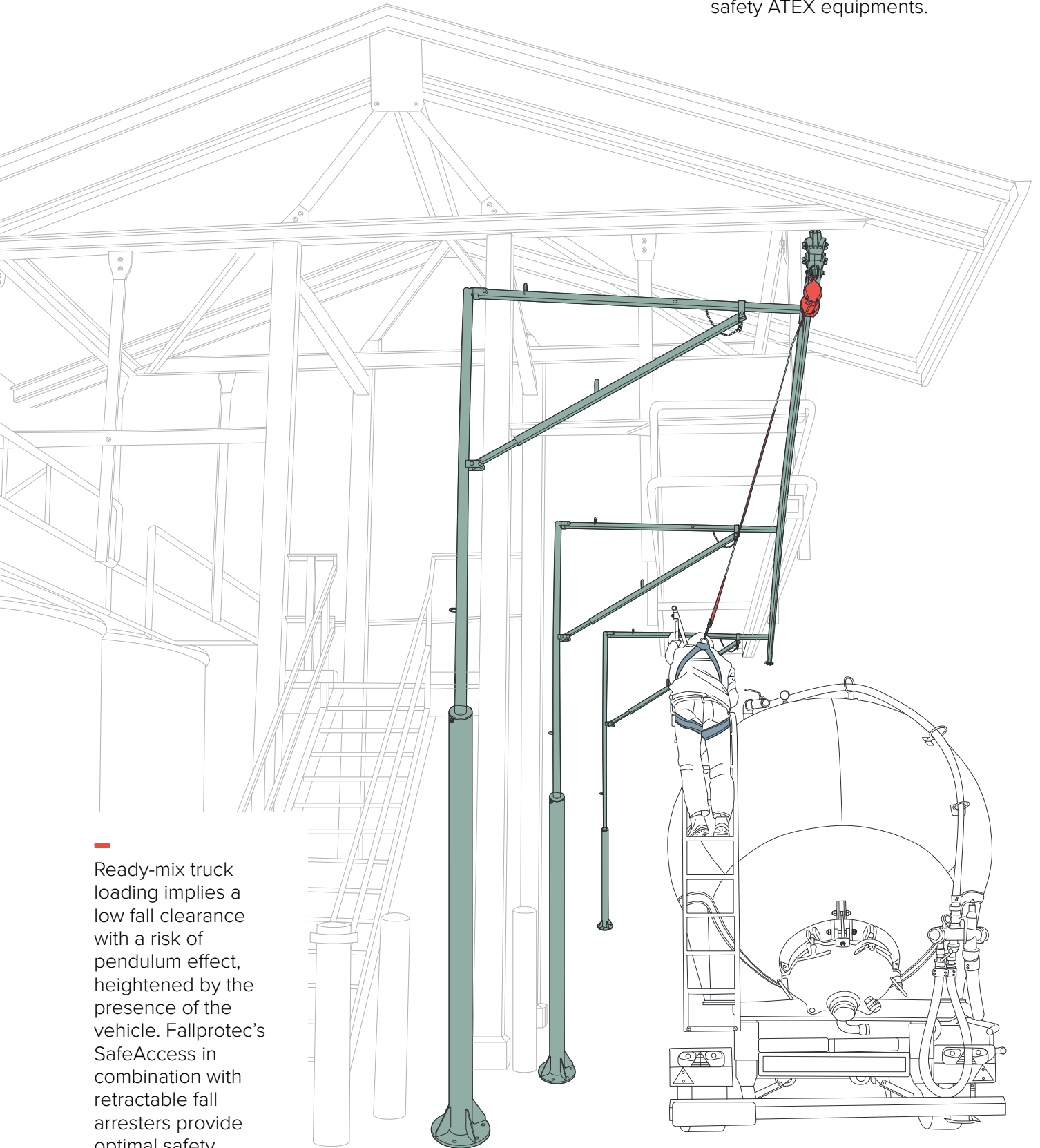

Ready-mix truck loading implies a low fall clearance with a risk of pendulum effect, heightened by the presence of the vehicle. Fallprotec's SafeAccess in combination with retractable fall arresters provide optimal safety.

The SafeAccess monorail of Fallprotec can be used in many combinations: ground, wall, ceiling or jibs above a loading bay. The robust design suits intensive applications, the rail remains usable years after being installed. In case of a fall, it is one of the very few systems where no part will need replacement. Combined with a safety block, it enables the safest possible fall arrest.

EN795:2012 Type D | CEN/TS16415:2013 | EN1808:2015



X 4
(2 users with
Flexbow)



Click here to
follow the product
YouTube playlist

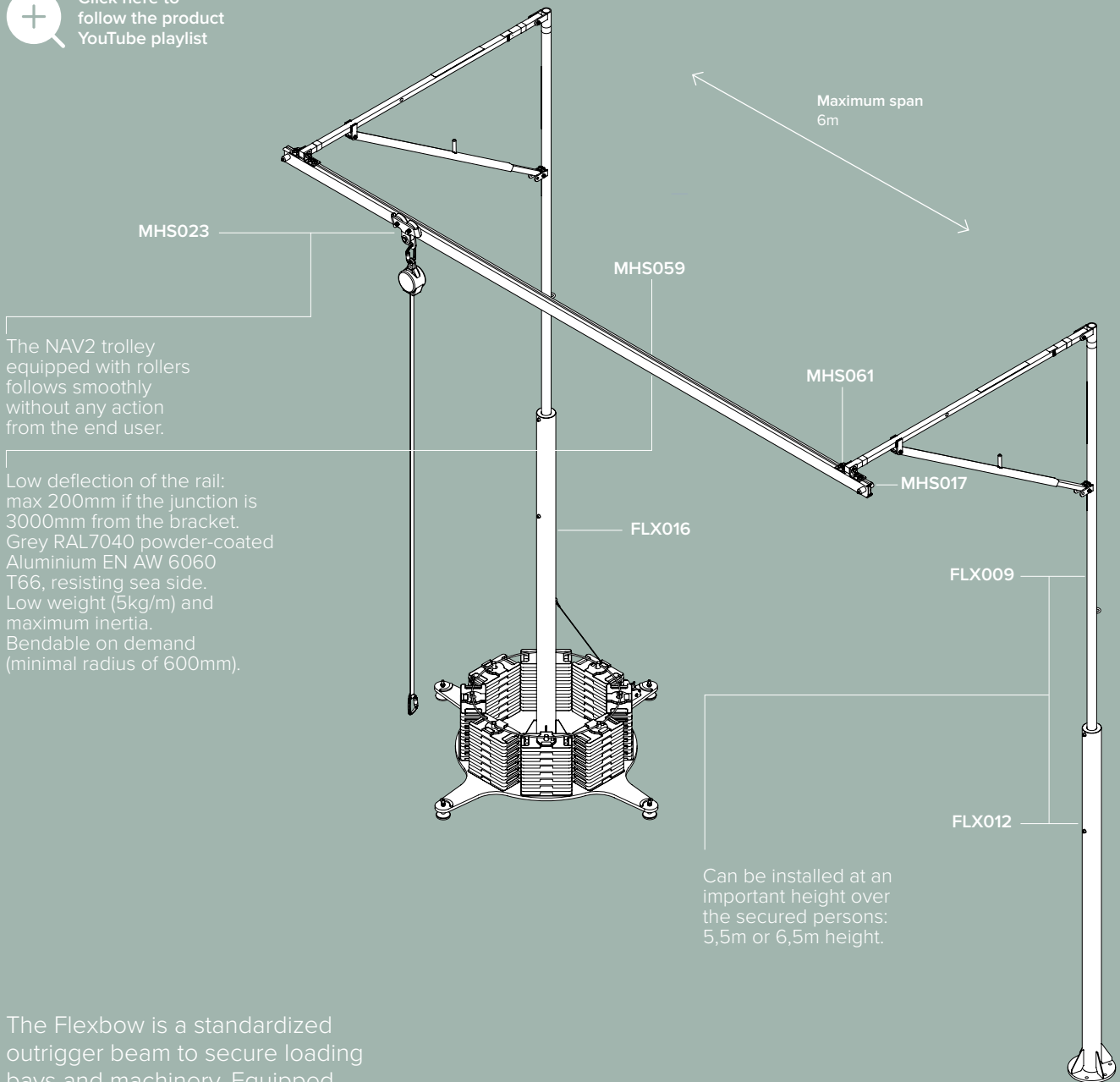

The Flexbow is a standardized outrigger beam to secure loading bays and machinery. Equipped with an integrated energy absorber, it is a lightweight and yet robust design for industrial applications with a minimum fall clearance of 4m. Several configurations (mobile, fixed on ground, fixed on wall...) are available.

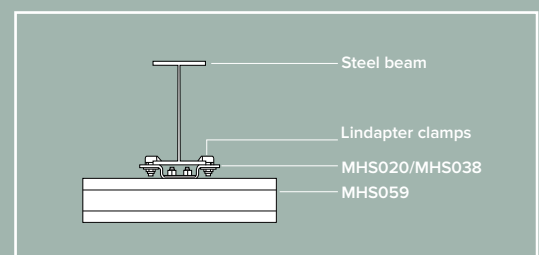

Access to silos and mixers

Workers are often required to enter confined spaces such as silos, sand storage containers or other confined spaces. Safety hazards associated with confined space include falls, asphyxiation and exposure to hazardous chemicals.

Workers must not be allowed to enter such spaces unless proper training, equipment and procedures are in place. A confined space must be evaluated to determine if it is a permit-required space.

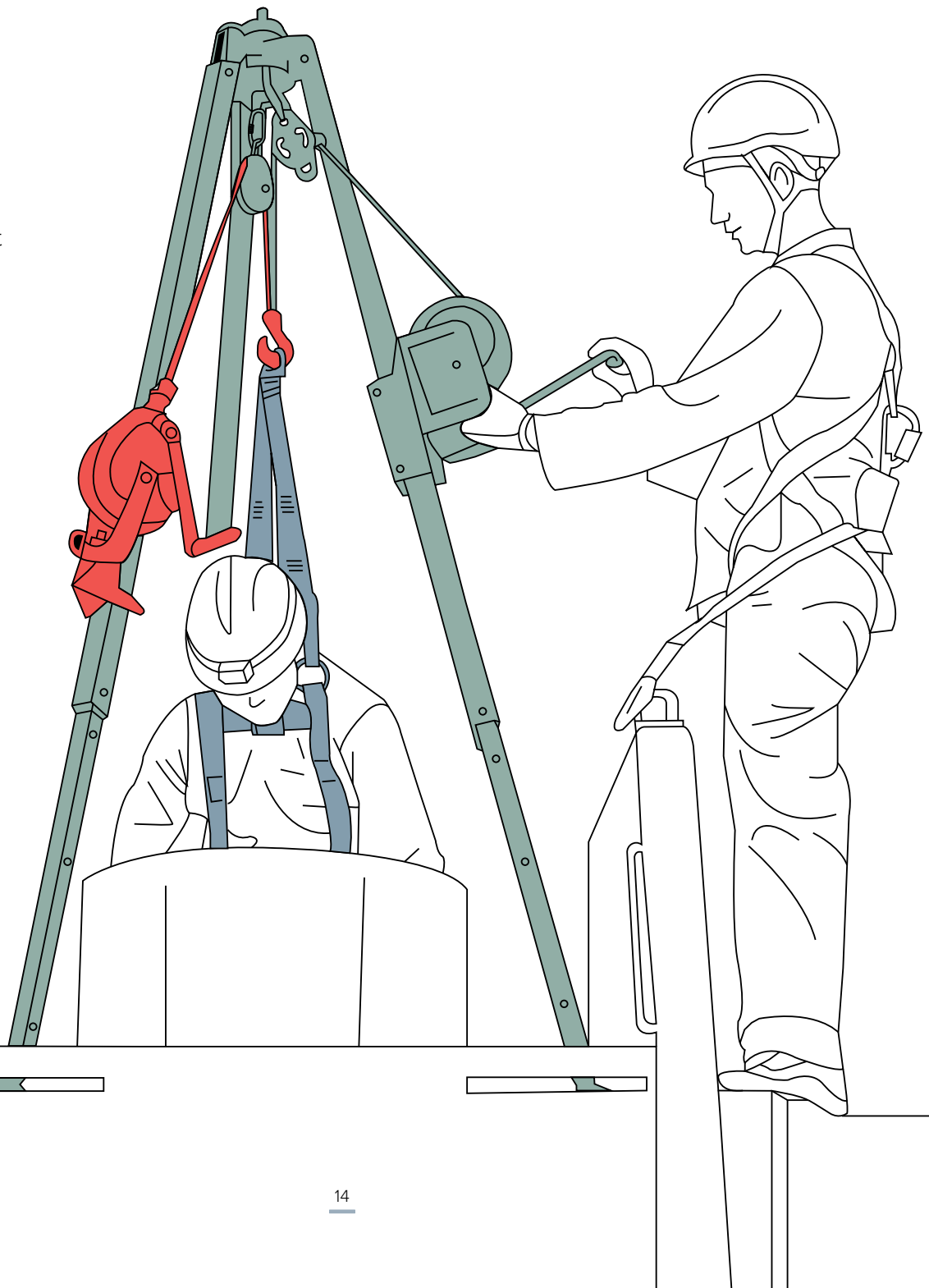

Davit arms and tripods are used to enhance the safety whilst entering, leaving, and accessing confined spaces. Rescue missions can be performed effectively by winching an injured person in a harness to safety. Fallprotecs's davits and tripods made in AISI304 has been specially developed for mobile use in conjunction with the RopeClimber hoist, HRA Rescue device and winches.

EN795:2012 Type B | CEN/TS16415:2013 | EN1808:2015



x 1



Click here to follow the product YouTube playlist

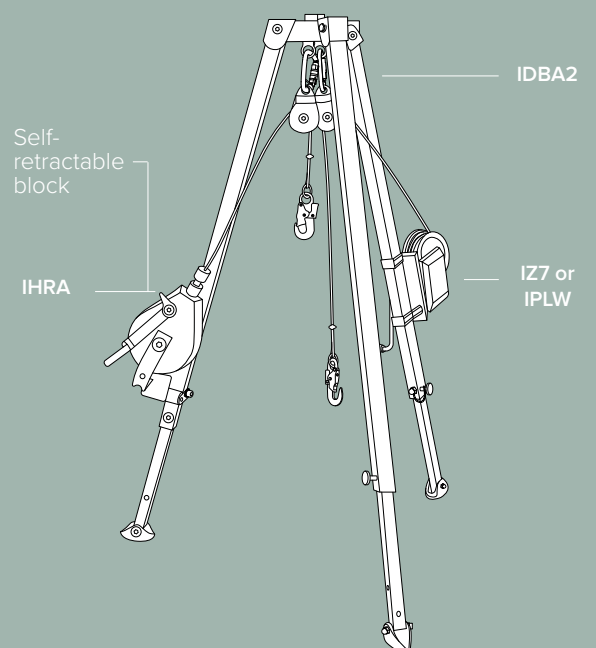
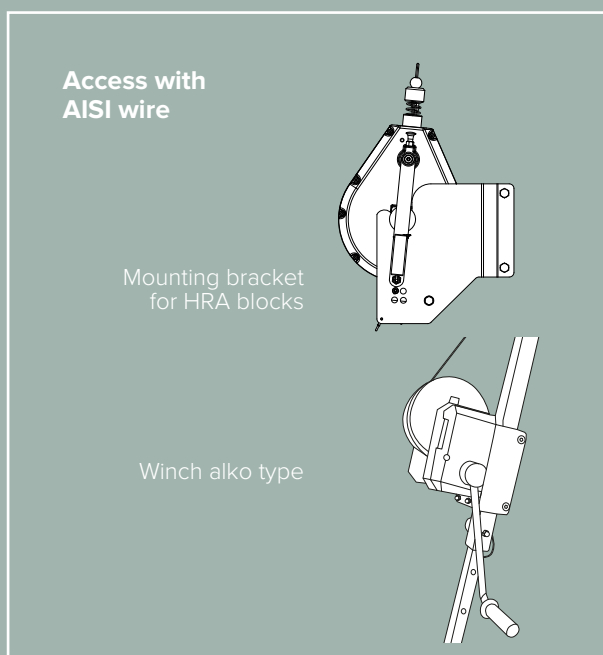
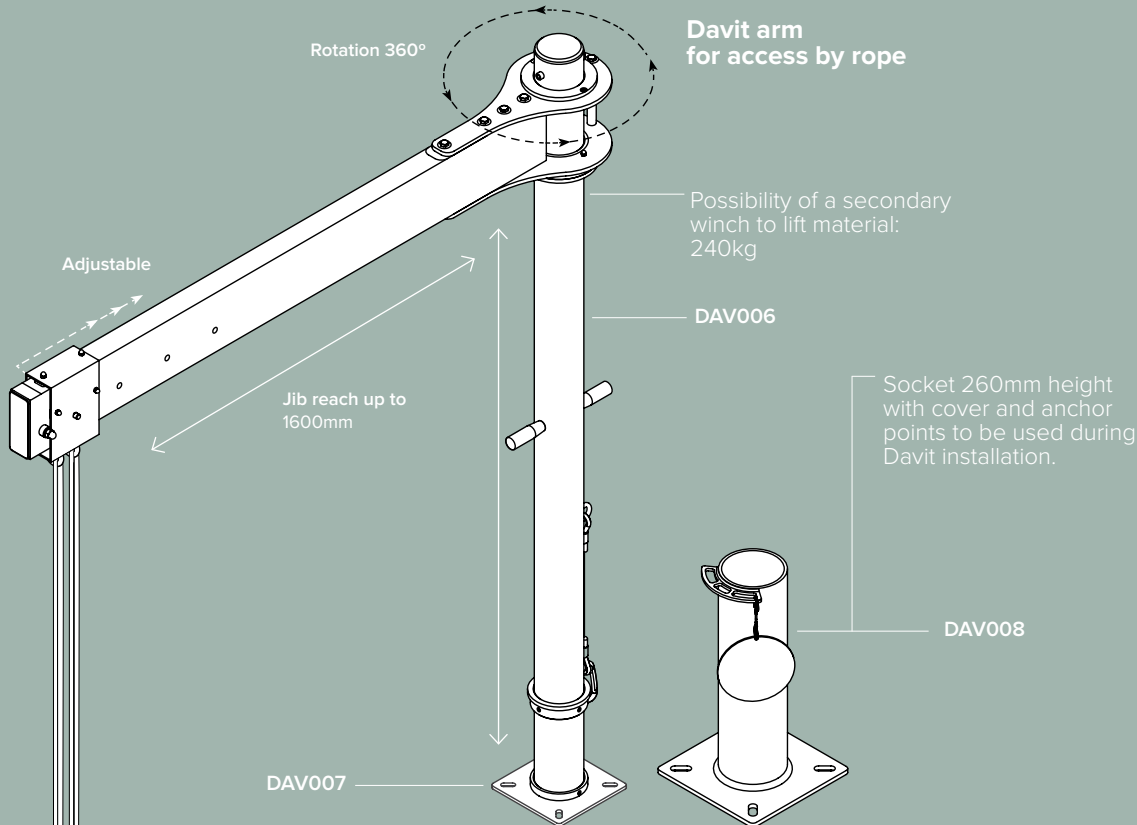

Fall protection & access equipment

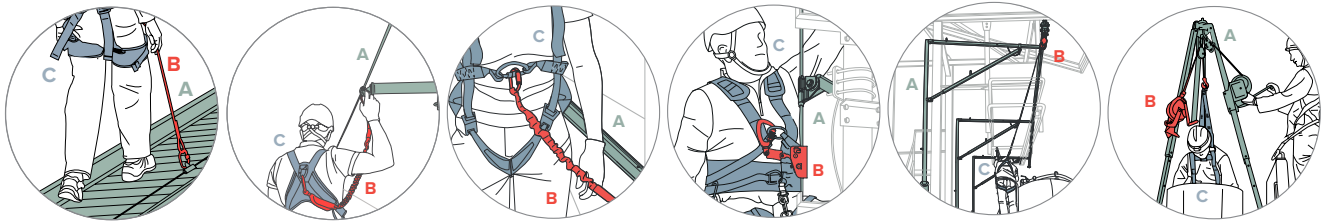

A

Anchorage

Structure capable of supporting 6kN per user attached as part of a complete personal fall arrest system which maintains a safety factor of at least two.

Fallprotec lifeline systems:

- 1) SecuRope cable Lifeline: Maintenance of roofs.
 - 2) SecuRope overhead cable Lifeline: Maintenance of machinery, gas detectors and kilns.
 - 3) SecuRail Rail Lifeline: Maintenance of machinery.
 - 4) SecuRope Vertical Cable Lifeline: Access to silos.
 - 5) SafeAccess fall arrest: loading ready-mix and cement trucks.
 - 6) Davit arm and tripods: Access to confined spaces.
- All systems are suitable for intensive use in complex industrial environments. Its components are reliable and durable.

Fixing brackets:

Fallprotec's internal engineering department offers bespoke fixation assemblies, adapted to various beam sizes and distances between them and walkways.

B

Connecting Devices

PPE Equipment with an energy-absorbing element to reduce the energy transmitted to the user's body in the event of a fall. Products such as shock absorbing lanyards or self-retracting lifelines connect a worker's harness to the anchorage.

Fallprotec PPE:

- 1) Elastic single and double lanyards of 1,5m or 2m length.
- 2) Self-retractable fall arresters from 2 - 65m length, with aluminium casing, webbing strap or galvanised steel rope.

C

Body Support

A safety harness is a personal protective equipment (PPE) that is designed to catch a person in the event of a fall while working at height. Our full body harness distributes fall arrest forces across the shoulders, thighs and pelvis.

Body support - Harnesses



Harness Prolight

EN361:2012



x 1



120

Resistant, lightweight fabric.
Comfortable for the user.

Connecting devices - PPE



Available with webbing strap or galvanised steel cable. The spring mechanism keeps a constant tension on the lanyard, facilitating the movement of the user. Certified for ceiling, wall and ground configuration; enable the user to reach areas further away from the lifeline.

The overspeed system stops a fall in a very short distance. The integrated energy absorption mechanism ensures that the maximal force transmitted to the end user is 6kN.

They can stop a fall within the first centimeters while absorbing the energy of it. Combined with SafeAccess, it is the safest fallarrest system by minimum fall clearance.

Complete range of self retractable lanyard with aluminium casing and galva steel rope.

IHWS

EN354/355/362



x 1



3,70





Connecting devices - PPE



Elastic lanyard 2m, energy absorber fitted with pivoting carabiner and hook 60mm opening

HAR076

EN354/355/362





 x 1	 0,60	 2m
 x 1 20mm opening Aluminium	 x 1 60mm opening Aluminium	



Single lanyard 2 m with energy absorber and 2 twist lock carabiners opening 20mm

HAR010

EN354/355/362





 x 1	 0,50	 2m
 x 2 20mm opening Zinc plated steel		



Double elastic lanyard 2m with energy absorber Material 2 carabiners opening 60 mm in alu+ 1 automatic carabiner in zinc plated steel

HAR077

EN354/355/362





 x 1	 0,80	 2m
 x 1 20mm opening Zinc plated steel	 x 2 60mm opening Aluminium	



Double lanyard 1,5 m fitted with energy absorber and 3 twist lock carabiner opening 20mm

HAR016

EN354/355/362

 x 1	 0,79	 1,5m
 x 3 20mm opening Zinc plated steel		

Fallprotec's products installations in cement factories

Fallprotec's internal engineering department had offered bespoke solutions for many industrial sites, while working with a worldwide network of specialized installers, in order to master the complete process of securing plants against the risk of fall.

The scope of offered services includes risk assessments, site surveys, engineering, installation, commissioning, inspection and maintenance.

[Click here to view more case studies worldwide on our website](#)



📍 Query
Arganda del rey, Spain

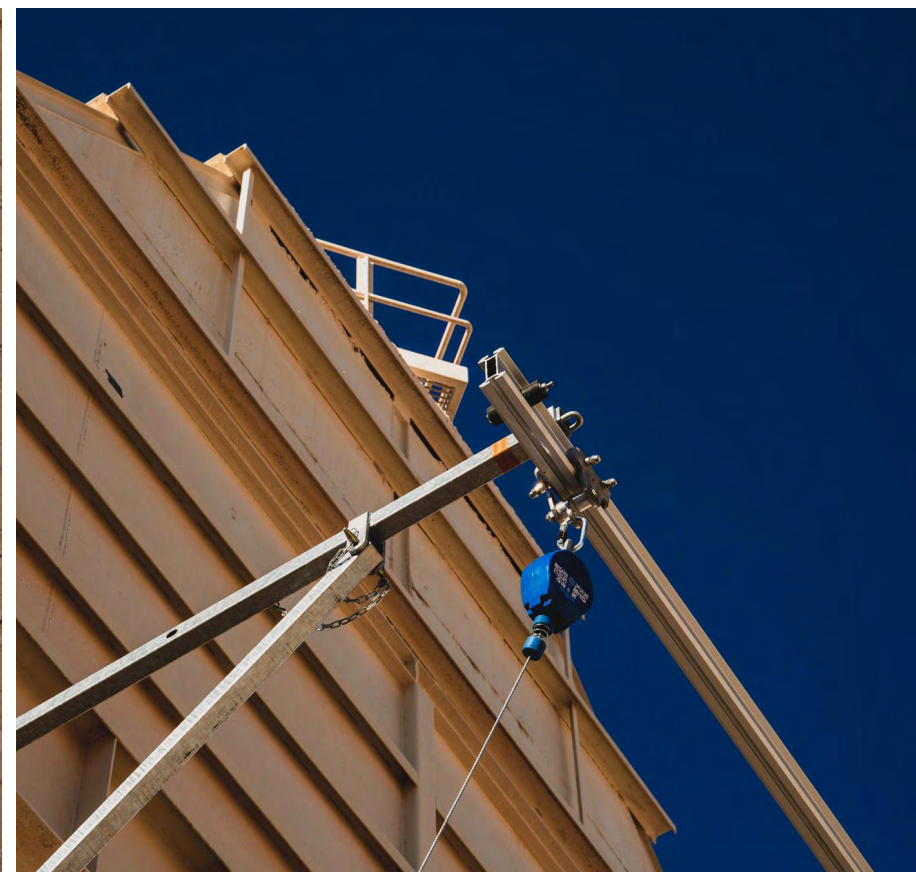

📍 Argos
Cartagena, Colombia



📍 LafargeHolcim
Calcuta, India



FALLPROTEC SA

43-45 ZA Op Zaemer
4959 Bascharage
Luxembourg
T: +352 26 55 09 30
F: +352 26 55 09 30 55
marketing@fallprotec.com

FALLPROTEC SA

Eduard Calvet i Pintó 4
Pol. Ind. Vallmorena
08339 Vilassar de Dalt
España
T: +34 93 114 22 31
info@fallprotec.es

FALLPROTEC CHINA

Room 213, Building 6
No. 398, Jinglian Road
Minhang District
Shanghai, China

T: +86 21 3126 8606
F: +86 21 2281 0168

+352 26 55 09 30
www.fallprotec.com

Follow us

fallprotec |    

FALLPROTEC

Height Safety Products

